

# ENX EASY

Product Information

**TABLE OF CONTENTS**

<b>1</b>	<b>TECHNICAL DATA</b>	<b>4</b>
	1.1 Absolute Maximum Rating .....	4
	1.2 General Data .....	4
	1.3 Incremental Interface .....	5
	1.4 Absolute Interface .....	5
	1.5 Angle Measurement .....	6
	1.6 Angle Alignment .....	7
	1.7 Mechanical Data .....	8
<b>2</b>	<b>ABSOLUTE ENCODER</b>	<b>10</b>
	2.1 SSI Mode .....	10
	2.2 BiSS-C Mode .....	10
<b>3</b>	<b>DEFINITIONS</b>	<b>11</b>
<b>4</b>	<b>TYPICAL MEASUREMENT RESULTS</b>	<b>13</b>
	4.1 Angle Error per Turn, calibrated .....	13
	4.2 Temperature Dependence .....	15
	4.3 Resolution Dependence .....	15
<b>5</b>	<b>PIN ASSIGNMENT</b>	<b>17</b>
	5.1 ENX 10 EASY .....	17
	5.2 ENX 16 EASY .....	20
<b>6</b>	<b>OUTPUT CIRCUITRY</b>	<b>24</b>
	6.1 ENX 10 EASY .....	24
	6.2 ENX 16 EASY .....	25
<b>7</b>	<b>ACCESSORIES</b>	<b>26</b>

**TRADEMARKS AND BRAND NAMES**

In the present document, registered brand names will not be tagged with their respective trademark. It must be understood that the brands (below list is not necessarily concluding) are protected by copyright and/or other intellectual property rights even if their legal trademarks are omitted.

BiSS © iC-Haus GmbH, DE-Bodenheim

CLIK-Mate™ © Molex, USA-Lisle, IL

## ENX EASY Encoders – Product Information

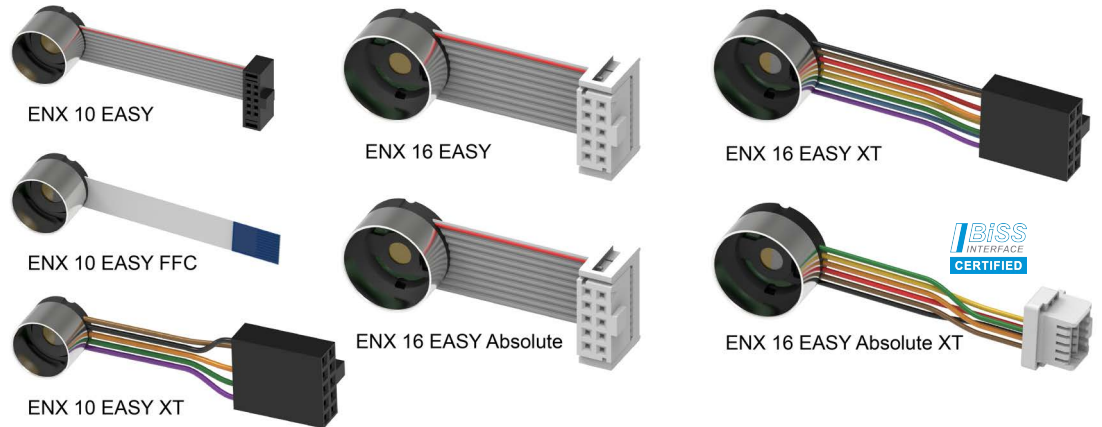

Figure 1 Overview

The ultra compact maxon EASY encoders use an interpolated Hall sensor angle measurement system to generate angle information of up to 4096 steps per turn. Electively or in combination available are incremental square wave signals and absolute angular values (SSI or BiSS-C).

The encoders are available in two form factors:

- Ø10 mm version for motors with outside diameter of Ø10 to Ø16 mm
- Ø16 mm version for motors with outside diameter of Ø16 mm and larger.

Depending on the model, as connection cables available are flat ribbon cables, flexible flat ribbon cables (FFC), or single strands.

The models with single strands are protected against reverse polarity are validated for ambient temperatures of  $-55\text{ °C}$  to  $+125\text{ °C}$  and manufactured as to IPC class 3, and are therefore suitable for demanding applications with extended temperature range and high quality requirements.

Pin-out for all versions is compatible to most maxon controllers with encoder interface.



### Note

*The listed data are for informational purposes only. None of the stated values or information may be used as an indicator of guaranteed performance.*



The following absolute encoder in the version with BiSS-C interface has the BiSS certification:

- ENX (ENC) 16 EASY Absolute XT

The corresponding certificate is available for download in the maxon web shop. Further information on the BiSS mode can be found in → chapter “2.2 BiSS-C Mode” on page 10.

# 1 TECHNICAL DATA

## 1.1 Absolute Maximum Rating

Parameter	Conditions	Min	Max	Unit
Supply voltage ( $V_{CC}$ )		-0.3	+6.0	V
Voltage at signal output ( $V_{signal}$ )		-0.3	+6.0	V
Supply current ( $I_{dd}$ )		-30	+220	mA
Signal output current ( $I_{signal}$ )	A,B,I; no supply voltage	-100	+100	mA
	DATA; no supply voltage	-10	+10	
ESD voltage ( $V_{esd}$ ), all pins	ENX 10 EASY (HBM 100 pF, 1.5 k $\Omega$ )		2	kV
	ENX 16 EASY (EN 61000-4-2)		>2	
Operating temperature ( $T_{amb}$ ) *1	ENX 10 EASY ENX 16 EASY ENX 16 EASY Absolute	-40	+100	°C
	ENX 10 EASY XT ENX 16 EASY XT ENX 16 EASY Absolute XT	-55	+125	
Storage temperature ( $T_{store}$ ) *1	ENX 10 EASY ENX 16 EASY ENX 16 EASY Absolute	-40	+100	°C
	ENX 10 EASY XT ENX 16 EASY XT ENX 16 EASY Absolute XT	-55	+125	
Humidity (condensation not permitted)	ENX 10 EASY ENX 16 EASY ENX 16 EASY Absolute	20	80	%rH
	ENX 10 EASY XT ENX 16 EASY XT ENX 16 EASY Absolute XT	20	100	

Annotation \*1 The included connectors are designed for a temperature range of -40...+105 °C.

## 1.2 General Data

Parameter	Conditions	Min	Typ	Max	Unit
Supply voltage ( $V_{CC}$ )	ENX 10 EASY ENX 10 EASY XT ENX 16 EASY ENX 16 EASY XT ENX 16 EASY Absolute	+4.5	5	+5.5	V
	ENX 16 EASY Absolute XT	+4.75	5	+5.25	
Supply current ( $I_{dd}$ ) Output pulse frequency <100 kHz, load resistor $\geq$ 100 k $\Omega$	ENX 10 EASY ENX 10 EASY XT ENX 16 EASY ENX 16 EASY XT ENX 16 EASY Absolute		22		mA
	ENX 16 EASY Absolute XT		26		mA

## 1.3 Incremental Interface

Parameter	Conditions	Min	Typ	Max	Unit
Number of channels	ChA, ChB, ChI	3			–
Counts per turn (N)	1...1024 factory-configurable	1	256	1024	cpt
Pulse frequency ( $f_{\text{pulse}}$ )	Maximum output pulse frequency		4		MHz
Signal output current ( $I_{\text{signal}}$ )	With Line Receiver RS-422	–60	±20	+60	mA
Signal voltage high ( $V_{\text{high}}$ )	$I_{\text{signal}} < 20$ mA, relative to $V_{\text{CC}}$	$V_{\text{CC}} - 0.5$ V			V
Signal voltage low ( $V_{\text{low}}$ )	$I_{\text{signal}} < 20$ mA			0.5	V
Transition time ( $t_{\text{trans}}$ )	Rise time/fall time ChA/B/I @ load resistor 100 $\Omega$ , $C_{\text{load}} \leq 200$ pF		10	25	ns

## 1.4 Absolute Interface

Parameter	Conditions	Min	Typ	Max	Unit
Steps per turn (N)	SSI/BiSS mode 12 bit		4096		steps
Signal output current ( $I_{\text{signal}}$ )	DATA output SSI/BiSS interface	–60	±20	+60	mA
Signal voltage high ( $V_{\text{high}}$ )	DATA output: $I_{\text{signal}} < 20$ mA, relative to $V_{\text{CC}}$	$V_{\text{CC}} - 1$ V			V
Signal voltage low ( $V_{\text{low}}$ )	DATA output: $I_{\text{signal}} < 20$ mA			0.5	V
Transition time ( $t_{\text{trans}}$ )	DATA output: Rise time/fall time, $C_{\text{load}} = 50$ pF			60	ns
System Clock ( $f_{\text{sys}}$ )		0.8	1.0	1.2	MHz
CLK Signal Frequency ( $f_{\text{clk}}$ )	SSI mode	0.04		4	MHz
	ENX 16 EASY Absolute BiSS mode	0.6		10	
	ENX 16 EASY Absolute XT BiSS mode	0.05		10	
Timeout ( $t_{\text{out}}$ )	ENX 16 EASY Absolute SSI mode	16			$\mu\text{s}$
	ENX 16 EASY Absolute BiSS-Modus	2			
	ENX 16 EASY Absolute XT BiSS mode	20			
	ENX 16 EASY Absolute XT BiSS mode	$1.5^* (1/f_{\text{clk}}) + 3.75$ $\mu\text{s}$			
Minimum input level CLK HIGH ( $V_{\text{high}}$ )	SSI/BiSS mode	2			V
Maximum input level CLK LOW ( $V_{\text{low}}$ )	SSI/BiSS mode			0.8	V
Input resistance CLK ( $R_{\text{input}}$ )	ENX 16 EASY Absolute		6.7		k $\Omega$
Input resistance differential CLK-CLK/	ENX 16 EASY Absolute XT		132		$\Omega$

## 1.5 Angle Measurement

**Conditions** All values at  $T = 25^{\circ}\text{C}$ ,  $n = 5000 \text{ rpm}$ ,  $V_{\text{CC}} = 5 \text{ V}$  unless otherwise specified.

**Definitions** See →page 11.

Parameter	Conditions	Min	Typ	Max	Unit
Counting direction of incremental signals (Dir)	Motor shaft movement for signal phase alignment "A leads B" as seen from the shaft end		CW		
Counting direction of absolute signals (Dir)	Motor shaft movement for increasing angle values as seen from the shaft end		CW		
State length ( $L_{\text{state}}$ ) and index pulse width ( $L_{\text{index}}$ synchronized with ChA/B), incremental	$N=1 \dots 128, 256, 512 \text{ cpt}$	45	90	135	$^{\circ}\text{e}$
	$N=1024 \text{ cpt}$	30	90	160	
	$N=500, 1000 \text{ cpt}$ and other non-binary number of impulses *2	30	90	250	
Minimum state duration ( $t_{\text{state}}$ ), incremental	$n \leq 25'000 \text{ rpm}$		500		ns
	$n \leq 90'000 \text{ rpm}$		125		
	$n > 90'000 \text{ rpm}$		62.5		
Integral Nonlinearity (INL)	All number of impulses		<1	2	$^{\circ}\text{m}$
Differential Nonlinearity (DNL)	$N=1 \dots 128, 256, 512 \text{ cpt}$		0.3	0.5	LSB
	$N=1024 \text{ cpt}$		0.6	0.9	
	$N=500, 1000 \text{ cpt}$ and other non-binary number of impulses *2			2	
Repeatability (Jitter), incremental	$N=512 \text{ cpt}$		0.5		LSB
	$N=1024 \text{ cpt}$		1		
Repeatability (Jitter)	All number of impulses		0.1		$^{\circ}\text{m}$
Repeatability (Jitter), absolute	ENX 16 EASY Absolute SSI/BiSS mode 12 bit		<4 *3		LSB
	ENX 16 EASY Absolute XT SSI/BiSS mode 12 bit		1 *3		
Phase delay A to B (Phase $\theta$ ), incremental	$N=1 \dots 512 \text{ cpt}$	45	90	135	$^{\circ}\text{e}$
	$N=513 \dots 1024 \text{ cpt}$	15	90	165	
Angle hysteresis (Hyst)	$N=1 \dots 1024 \text{ cpt}$	0.17			$^{\circ}\text{m}$
Bandwidth of analog signal path	Typical equivalent bandwidth of single pole low-pass filter		16		kHz
Delay of digital signal path	Typical latency of digital signal processing		2		$\mu\text{s}$

**Annotations** \*2 With non-binary number of impulses, individual states are systematically omitted from the maximum possible number of states per turn. Thereby, the associated initial impulses are being extended and thus deteriorate the resolution-dependent characteristics.

\*3 When reading the absolute angle at the same position, six standard deviations of the resulting sequence of values can approach 1, respectively 4 LSB.

## 1.6 Angle Alignment

The angle value "zero" of the absolute encoder and the index of the incremental encoder is factory-programmed to the commutation angle "zero" of the used EC (BLCD) motor. The "zero" commutation angle is 30°e after the zero crossing of the back EMF (→Figure 2).

- When assembled onto a motor with several pole pairs (n), the absolute encoders will show the angle value "zero" and the incremental encoders the index **once per mechanical turn**.
- Due to its multiple sets of pole pairs, the **motor** will show this commutation angle **n times per mechanical turn**.

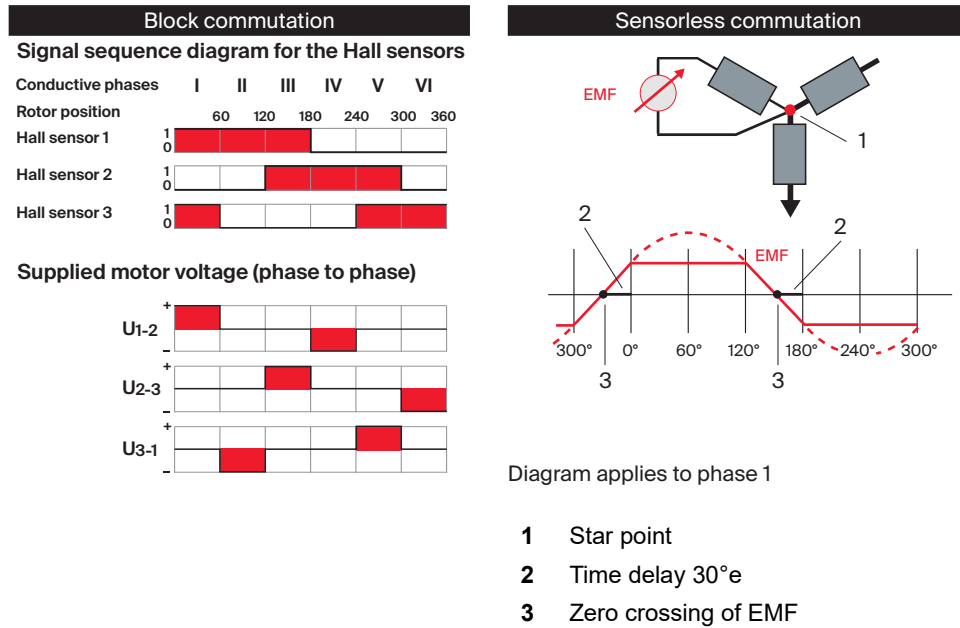

Figure 2 Block Commutation of EC (BLDC) Motors – Definition of Phases

### 1.7 Mechanical Data

Parameter	Conditions	Value	Unit
Dimensions (D x L), without flange	ENX 10 EASY	Ø10.0 x 8.5	mm
	ENX 10 EASY FFC	Ø10.0 x 8.5	
	ENX 10 EASY XT	Ø10.0 x 8.5	
	ENX 16 EASY	Ø15.8 x 8.5	
	ENX 16 EASY Absolute	Ø15.8 x 8.5	
	ENX 16 EASY XT	Ø15.8 x 8.5	
	ENX 16 EASY Absolute XT	Ø15.8 x 9.0	
Moment of inertia (Jt)	motor shaft Ø1...8 mm	0.01...0.7	g cm <sup>2</sup>
Standard cable length (Lc)	ENX 10 EASY	150 / 1000	mm
	ENX 10 EASY FFC	138	
	ENX 10 EASY XT	300	
	ENX 16 EASY	200 / 300 / 1000	
	ENX 16 EASY Absolute	200 / 300 / 1000	
	ENX 16 EASY XT	500 / 1000 / 1500	
	ENX 16 EASY Absolute XT	500 / 1000	

Table 1 Technical Data

#### 1.7.1 ENX 10 EASY

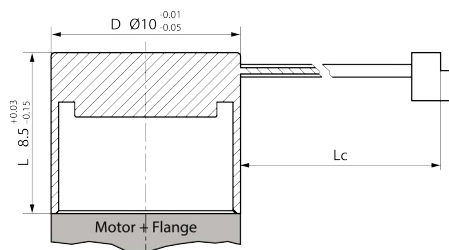

Figure 3 ENX 10 EASY – Dimensional Drawing [mm]

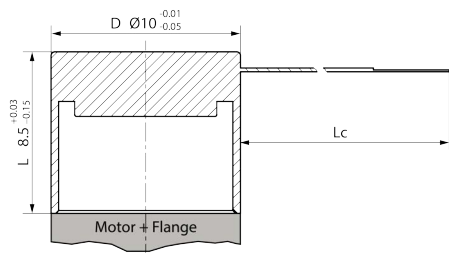

Figure 4 ENX 10 EASY FFC – Dimensional Drawing [mm]



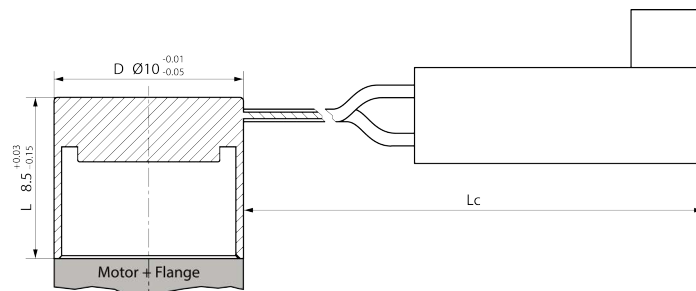

Figure 5 ENX 10 EASY XT – Dimensional Drawing [mm]

### 1.7.2 ENX 16 EASY

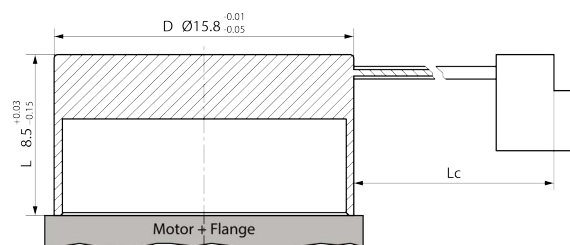

Figure 6 ENX 16 EASY / ENX 16 EASY Absolute – Dimensional Drawing [mm]

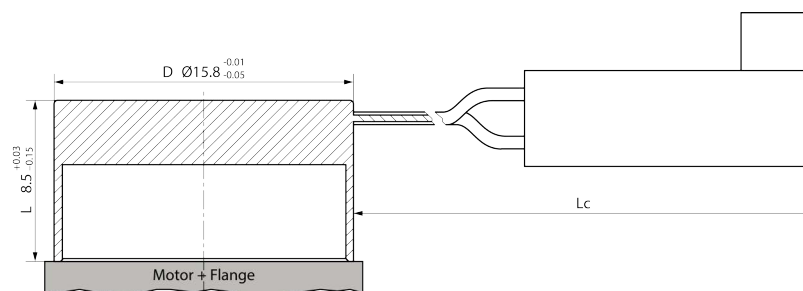

Figure 7 ENX 16 EASY XT – Dimensional Drawing [mm]

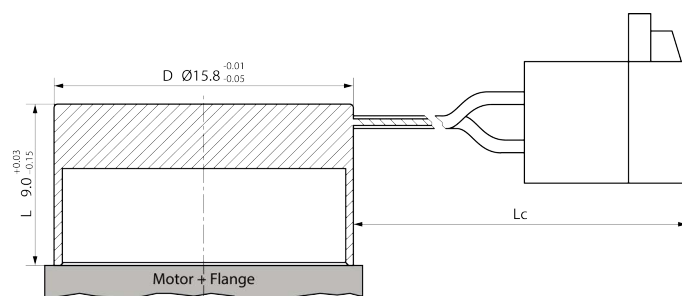

Figure 8 ENX 16 EASY Absolute XT – Dimensional Drawing [mm]

## 2 ABSOLUTE ENCODER

The «ENX EASY» absolute encoders provide the functionality of a single-turn absolute encoder. Two interface protocol variants are factory-configurable; SSI and BiSS-C.

### 2.1 SSI Mode

- The wait time after reading of last bit must be larger than Timeout ( $t_{out}$ ).
- Protocol: 13 bit data, MSB first, last bit always zero, gray coded
- A complete reading cycle at maximum clock rate can be calculated using the following formula:

$$13 \cdot \frac{1}{4MHz} + t_{out}$$

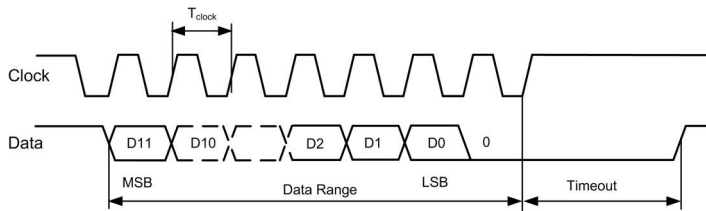

Figure 9 Timing of EASY Absolute in SSI Mode

### 2.2 BiSS-C Mode

- The wait time after reading of last bit must be larger than Timeout ( $t_{out}$ ).
- Protocol: 3 bit start sequence {Ack, Start, CDS} fixed values, 12 bit data (MSB first), 2 bits Error/Warning, 6 bit CRC (polynomial: 0b1000011, inverted mode, binary coded).
- A complete reading cycle at maximum clock rate takes at least as follows:

#### ENX 16 EASY Absolute

$$23 \cdot \frac{1}{10MHz} + t_{out}$$

#### ENX 16 EASY Absolute XT

$$23 \cdot \frac{1}{10MHz} + \left(1.5 \cdot \frac{1}{10MHz} + t_{out}\right)$$

- The interface is BiSS-C-compatible and occasionally also certified (→check Figure 1).
- A BiSS master (e.g. motion controller) can automatically configure its interface to the sensor using the "Auto Profile Detection Concept". (Number of bits ST, CRC, nE, nW). In this regard, the encoder is preconfigured according to the BiSS Profile 1 (BP1) specification. For more information on the specification of the BiSS-C interface and the BiSS profile 1: →<http://biss-interface.com/> (section "Downloads").
- In the simplest configuration, the controller is the master and ENX 16 EASY Absolute the only slave.

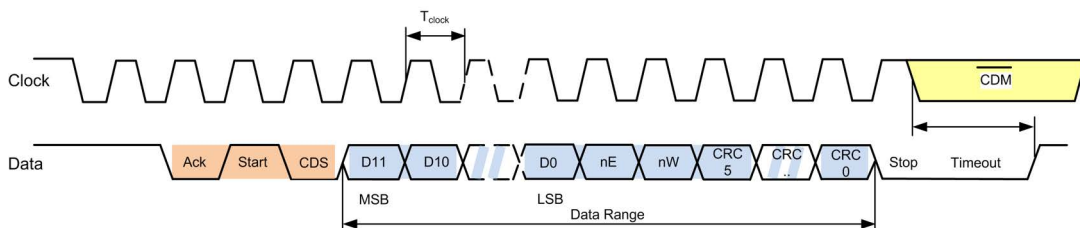

Figure 10 Timing of EASY Absolute in BiSS-C Mode

### 3 DEFINITIONS

Metric	Definition	Illustration
Angle Error [°m]	Difference of measured and true angular shaft position at each position.	
Average Angle Error [°m]	Average of Angle Error at each position, over a given number of turns.	
Integral Nonlinearity (INL) [°m]	Peak-to-peak value of Average Angle Error.	
Jitter (Repeatability) [°m] or [LSB]	Six standard deviations of Angle Error per turn (at each position, over a given number of turns). <b>Jitter [°m]</b> is typically independent of the resolution and defines the maximum useful positioning repeatability. <b>Jitter [LSB]</b> is resolution-dependent. At given Jitter [°m], the value is roughly proportional to resolution.	
Least Significant Bit (LSB)	Minimum measurable difference between two angle values at given resolution (= quadcount, = State).	
State Error [LSB]	Difference between actual state length and average state length.	
Average State Error [LSB]	Average of State Error over a number of turns for each state of a turn.	
Differential Nonlinearity [DNL]	Maximum positive or negative Average State Error.	

Metric	Definition	Illustration
Minimum State Length [°e]	Minimum measured state length within a number of turns relative to pulse length.	
Maximum State Length [°e]	Maximum measured state length within a number of turns relative to pulse length.	
Minimum State Duration [ns]	By chip limited minimum time separation between two A/B transitions.	
Phase delay $\theta$ [°e]	Time difference of rising edge A to B relative to duration of positive level of A.	

Table 2 Definitions

## 4 TYPICAL MEASUREMENT RESULTS

### 4.1 Angle Error per Turn, calibrated

The average angle error [°m] and the repeatability (Jitter) [°m] are independent of the chosen resolution. The metrics given in LSB are resolution-dependent.

Below graphs show angle error measurements of an incremental encoder configured in various resolutions and an absolute encoder with maximum resolution under following conditions: Measurement of 25 turns at  $V_{CC}=5\text{ V}$ ,  $n=5000\text{ rpm}$ ,  $T=25^\circ\text{C}$ .

Resolution	Graph	Analysis	
16 cpt		INL Jitter DNL Min State Max State	0.7°m 0.1°m = 0.02 LSB 0.03 LSB 0.97 LSB = 87°e 1.02 LSB = 92°e
256 cpt		INL Jitter DNL Min State Max State	0.7°m 0.1°m = 0.25 LSB 0.12 LSB 0.9 LSB = 81°e 1.1 LSB = 99°e
512 cpt		INL Jitter DNL Min State Max State	0.7°m 0.1°m = 0.5 LSB 0.3 LSB 0.85 LSB = 76°e 1.3 LSB = 117°e
1024 cpt		INL Jitter DNL Min State Max State	0.7°m 0.1°m = 1 LSB 0.5 LSB 0.8 LSB = 72°e 1.5 LSB = 135°e

Resolution	Graph	Analysis	
500 cpt (non-binary)		INL Jitter DNL Min State Max State	0.7°m 0.1°m = 0.5 LSB 0.75 LSB 0.85 LSB = 76°e 1.75 LSB = 175°e
1000 cpt (non-binary)		INL Jitter DNL Min State Max State	0.7°m 0.1°m = 1 LSB 1.5 LSB 0.75 LSB = 67°e 2.5 LSB = 225°e
12 bit (Absolute)		INL Jitter	0.7°m 0.30°m = 3.5 LSB
12 bit (Absolute XT)		INL Jitter	0.7°m 0.1°m = 1 LSB

Table 3 Typical Measurement Results

### 4.2 Temperature Dependence

INL, DNL and Min State are basically temperature-independent. Max State and, in particular, Jitter increases with temperature (due to thermal noise). The increasing Max State is the consequence of the increasing Jitter.

Figure 11 shows the temperature dependence of nine «ENX 16 EASY» encoders on «DCX 22» motors under the following conditions:  $V_{CC}=5\text{ V}$ , 10'000 rpm, 1 kΩ load, 1024 cpt. The gray-shaded areas (-55/+125 °C) indicate the extended temperature range of the XT variants.

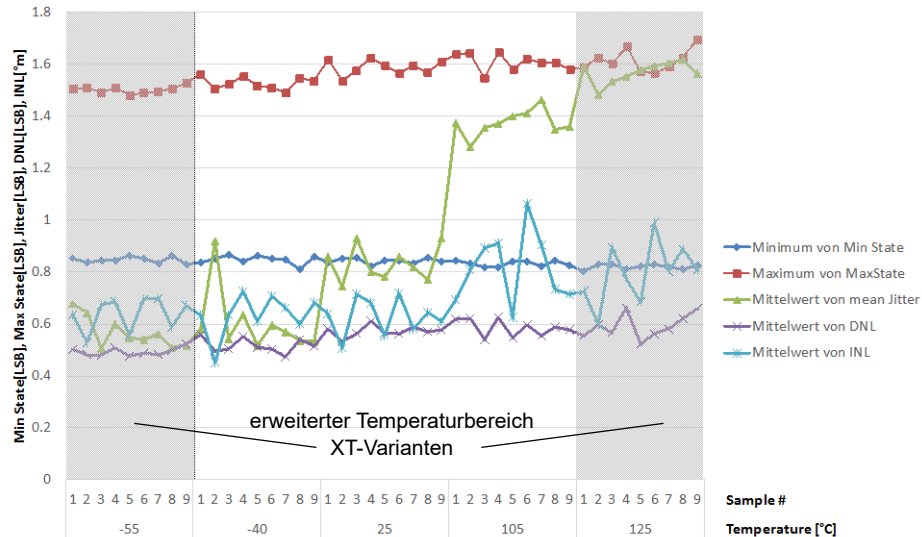

Figure 11 Temperature Dependence

### 4.3 Resolution Dependence

INL and Jitter [°m] are independent of resolution (→Table 3). Resolution-dependent metrics deteriorate with increased resolution, particularly with non-binary resolutions (→Figure 13)

Figure 12 shows the resolution dependence of eight samples of EASY encoders under following conditions:  $V_{CC}=5\text{ V}$ , 10'000 rpm, 1 kΩ load, 25°C, binary resolution

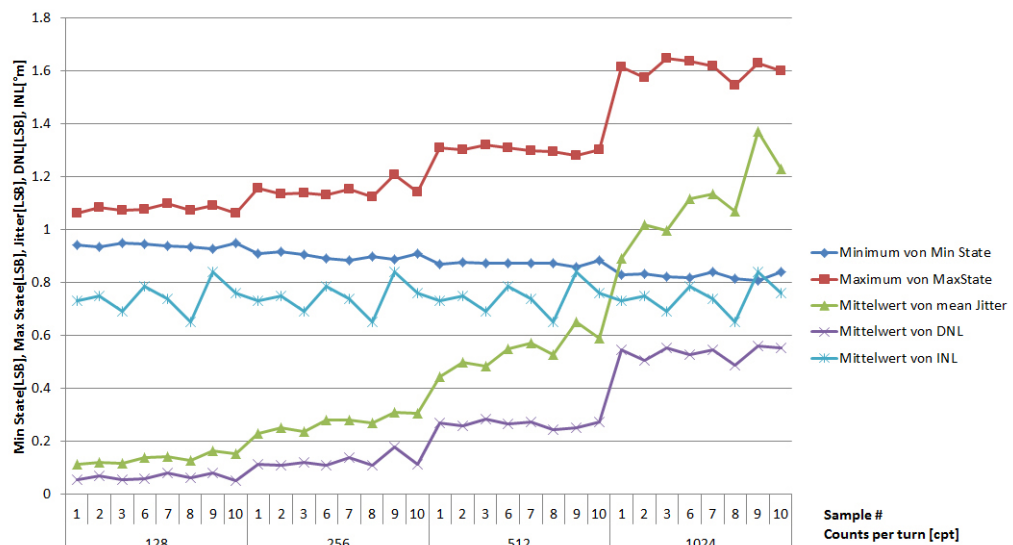

Figure 12 Resolution Dependence (binary Resolutions)

Figure 13 shows the resolution dependence of eight samples of EASY encoders under following conditions:  $V_{cc}=5\text{ V}$ ,  $10'000\text{ rpm}$ ,  $1\text{ k}\Omega$  load,  $25^\circ\text{C}$ , non-binary resolution

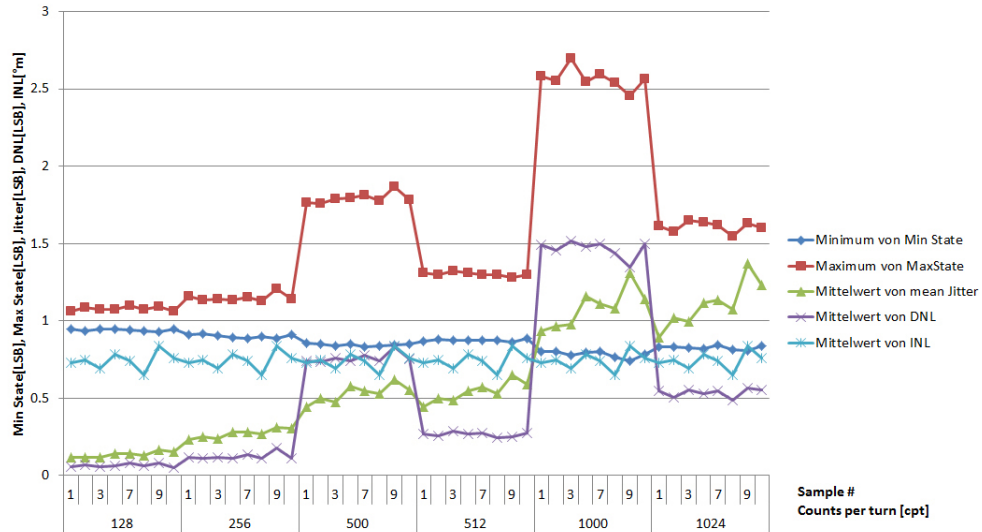

Figure 13 Resolution Dependence (Comparison binary/non-binary Resolutions)



## 5 PIN ASSIGNMENT



### Maximum permitted Supply Voltage

- Make sure that supply power is within stated range.
- Supply voltages exceeding the stated range will destroy the unit.
- Connect the unit only when supply voltage is switched off ( $V_{cc}=0$ ).

### 5.1 ENX 10 EASY

#### ENX 10 EASY

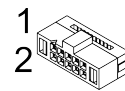
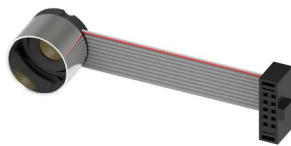

Figure 14 ENX 10 EASY – Cable Plug

Pin	Color	Signal	Description
1	red	do not connect	—
2	gray	$V_{cc}$	Power supply voltage
3	gray	GND	Ground
4	gray	do not connect	—
5	gray	ChA/	Channel A complement
6	gray	ChA	Channel A
7	gray	ChB/	Channel B complement
8	gray	ChB	Channel B
9	gray	ChI/	Channel I (index) complement
10	gray	ChI	Channel I (Index)

Table 4 ENX 10 EASY – Pin Assignment



### ENX 10 EASY: Assignment Pin 1 and Pin 4

Externally applied voltages at these pins can destroy the device.

Cable Plug ENX 10 EASY	
Connector	IDC socket, pitch 1.27 mm, 5 x 2 poles
Mating plug	Pin header, pitch 1.27 mm, 5 x 2 poles, pin length 3.05 mm/0.12 inch (e.g. Samtec FTSH series)

Table 5 ENX 10 EASY – Specifications Cable Plug

**ENX 10 EASY FFC**

Figure 15 ENX 10 EASY FFC – Cable Plug

Pin	Color	Signal	Description
1		do not connect	—
2		V <sub>CC</sub>	Power supply voltage
3		GND	Ground
4		do not connect	—
5		ChA/	Channel A complement
6		ChA	Channel A
7		ChB/	Channel B complement
8		ChB	Channel B
9		ChI/	Channel I (index) complement
10		ChI	Channel I (Index)

Table 6 ENX 10 EASY FFC – Pin Assignment

**ENX 10 EASY FFC: Assignment Pin 1 and Pin 4**

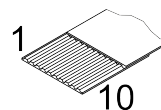
Externally applied voltages at these pins can destroy the device.

Cable Plug ENX 10 EASY FFC	
Connector	Flexprint connector, pitch 0.5 mm, 10 poles
Mating plug	Flexprint plug, pitch 0.5 mm, 10 poles (such as Molex 52745-1097)

Table 7 ENX 10 EASY FFC – Specifications Cable Plug

## ENX 10 EASY XT



Figure 16 ENX 10 EASY XT – Cable Plug

Pin	Color	Signal	Description
1		not connected	—
2	black	V <sub>CC</sub>	Power supply voltage
3	brown	GND	Ground
4		not connected	—
5		not connected	—
6	orange	ChA	Channel A
7		not connected	
8	green	ChB	Channel B
9		not connected	—
10	violett	ChI	Channel I (Index)

Table 8 ENX 10 EASY XT – Pin Assignment

Cable Plug ENX 10 EASY XT	
Connector	Crimp contact housing, pitch 2.54 mm, 5 x 2 poles
Mating plug	Pin header, pitch 2.54 mm, 5 x 2 poles (EN 60603-13/DIN 41651)

Table 9 ENX 10 EASY XT – Specifications Cable Plug

## 5.2 ENX 16 EASY

### ENX 16 EASY

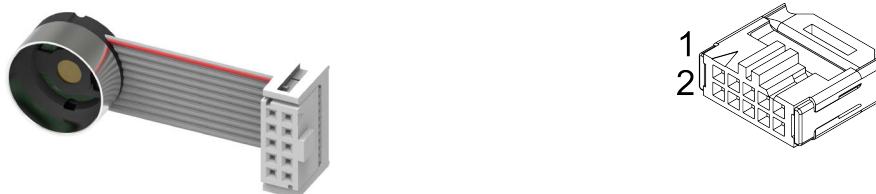

Figure 17 ENX 16 EASY – Cable Plug

Pin	Color	Signal	Description
1	red	not connected	—
2	gray	V <sub>cc</sub>	Power supply voltage
3	gray	GND	Ground
4	gray	not connected	—
5	gray	ChA/	Channel A complement
6	gray	ChA	Channel A
7	gray	ChB/	Channel B complement
8	gray	ChB	Channel B
9	gray	ChI/	Channel I (index) complement
10	gray	ChI	Channel I (Index)

Table 10 ENX 16 EASY – Pin Assignment

Cable Plug ENX 16 EASY	
Connector	IDC socket, pitch 2.54 mm, 5 x 2 poles
Mating plug	Pin header, pitch 2.54 mm, 5 x 2 poles (EN 60603-13/DIN 41651)

Table 11 ENX 16 EASY – Specifications Cable Plug

## ENX 16 EASY XT

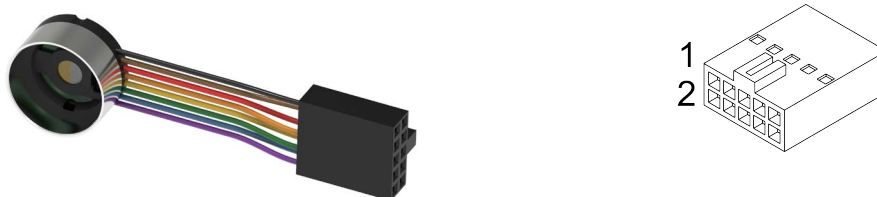

Figure 18 ENX 16 EASY XT – Cable Plug

Pin	Color	Signal	Description
1		not connected	—
2	black	V <sub>CC</sub>	Power supply voltage
3	brown	GND	Ground
4		not connected	—
5	red	ChA/	Channel A complement
6	orange	ChA	Channel A
7	yellow	ChB/	Channel B complement
8	green	ChB	Channel B
9	blau	ChI/	Channel I (index) complement
10	violett	ChI	Channel I (Index)

Table 12 ENX 16 EASY XT – Pin Assignment

Cable Plug ENX 16 EASY XT	
Connector	Crimp contact housing, pitch 2.54 mm, 5 x 2 poles
Mating plug	Pin header, pitch 2.54 mm, 5 x 2 poles (EN 60603-13/DIN 41651)

Table 13 ENX 16 EASY XT – Specifications Cable Plug

**ENX 16 EASY ABSOLUTE**

Figure 19 ENX 16 EASY Absolute – Cable Plug

Pin	Color	Signal	Description
1	red	SSI/BiSS DATA	Absolute encoder Data
2	gray	V <sub>CC</sub>	Power supply voltage
3	gray	GND	Ground
4	gray	SSI/BiSS CLK	Absolute encoder Clock
5	gray	ChA/	Channel A complement
6	gray	ChA	Channel A
7	gray	ChB/	Channel B complement
8	gray	ChB	Channel B
9	gray	ChI/	Channel I (index) complement
10	gray	ChI	Channel I (Index)

Table 14 ENX 16 EASY Absolute – Pin Assignment

**ENX 16 EASY Absolute: Assignment Pin 1 and Pin 4**

Externally applied voltages at these pins can destroy the device.

Cable Plug ENX 16 EASY Absolute	
Connector	IDC socket, pitch 2.54 mm, 5 x 2 poles
Mating plug	Pin header, pitch 2.54 mm, 5 x 2 poles (EN 60603-13/DIN 41651)

Table 15 ENX 16 EASY Absolute – Specifications Cable Plug

## ENX 16 EASY ABSOLUTE XT

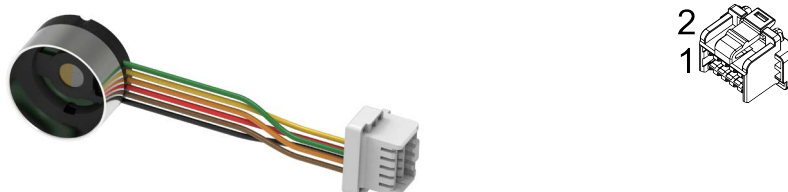

Figure 20 ENX 16 EASY Absolute XT – Cable Plug

Pin	Color	Signal	Description
1		not connected	—
2		not connected	—
3		not connected	—
4		not connected	—
5	green	SSI/BiSS CLK	Absolute encoder Clock
6	yellow	SSI/BiSS CLK/	Absolute encoder Clock complement
7	orange	SSI/BiSS DATA	Absolute encoder Data
8	red	SSI/BiSS DATA/	Absolute encoder Data complement
9	brown	GND	Ground
10	black	V <sub>cc</sub>	Power supply voltage

Table 16 ENX 16 EASY Absolute XT – Pin Assignment

Cable Plug ENX 16 EASY Absolute XT	
Connector	Molex CLIK-Mate, pitch 1.5 mm, 5 x 2 poles (503149 series)
Mating plug	Molex CLIK-Mate, pitch 1.5 mm, 5 x 2 poles (503154 series)

Table 17 ENX 16 EASY Absolute XT – Specifications Cable Plug

## 6 OUTPUT CIRCUITRY

The following figures show the conceptual output schematics of the different encoders including ESD protection circuitry.

### 6.1 ENX 10 EASY

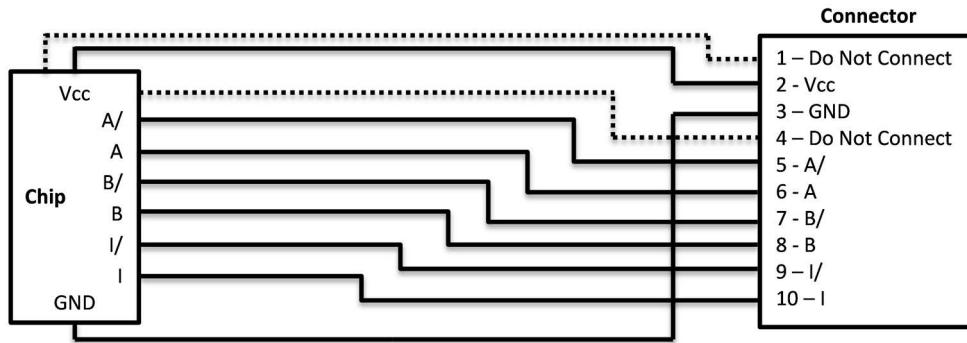

Figure 21 ENX 10 EASY / ENX 10 EASY FFC – Output Circuitry

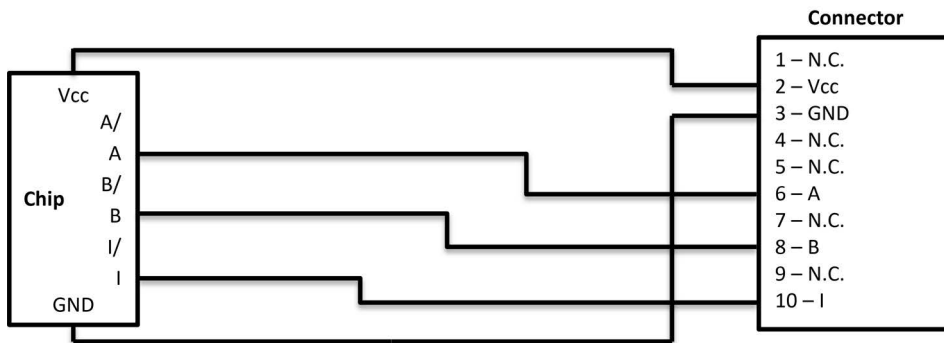

Figure 22 ENX 10 EASY XT – Output Circuitry



6.2 ENX 16 EASY

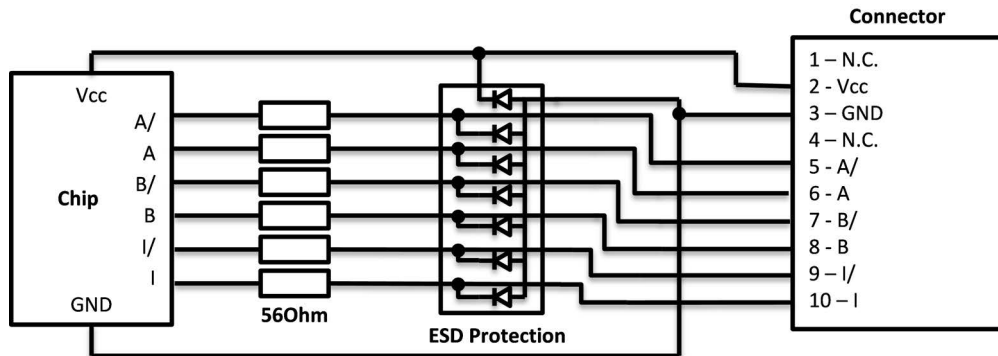

Figure 23 ENX 16 EASY / ENX 16 EASY XT – Output Circuitry

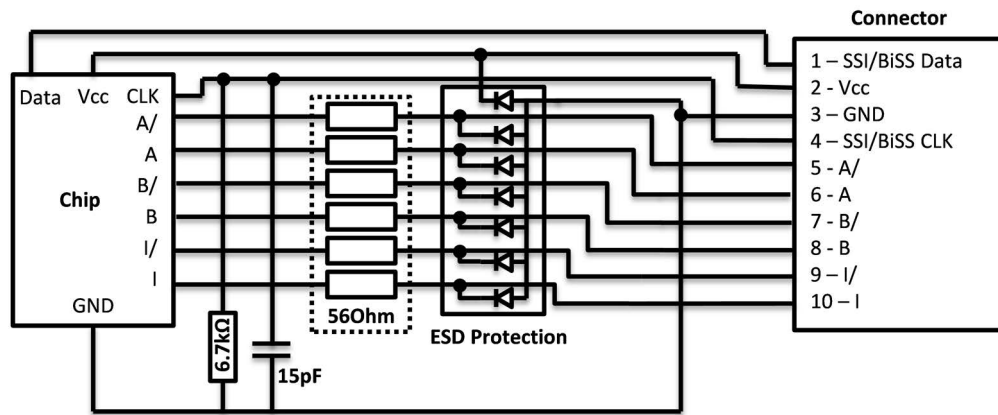

Figure 24 ENX 16 EASY Absolute – Output Circuitry

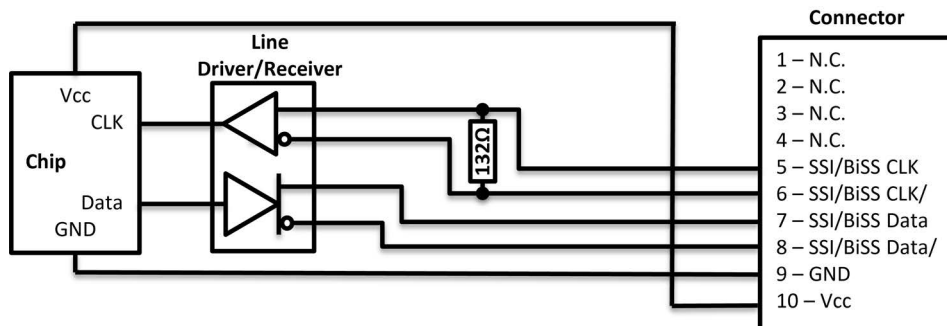

Figure 25 ENX 16 EASY Absolute XT – Output Circuitry

## 7 ACCESSORIES

Order number	Description	
405120	Plug-in adapter	To connect the ENX 10 EASY to... <ul style="list-style-type: none"> <li>• EPOS2 Positioning Controllers,</li> <li>• ESCON Servo Controllers and</li> <li>• other controllers.</li> </ul>
488167	Adapter EASY Absolute	To connect the ENX 16 EASY Absolute to a maxon controller with absolute encoder interface: <ul style="list-style-type: none"> <li>• EPOS2 50/5 (SSI only)</li> <li>• EPOS3 70/10 EtherCat (SSI only)</li> <li>• EPOS2 70/10 (SSI only)</li> <li>• MAXPOS 50/5 (SSI or BiSS-C)</li> </ul> Suitable signal cables sold separately.
506579	Adapter FPC 10 poles	To connect the ENX 10 EASY FFC to... <ul style="list-style-type: none"> <li>• EPOS2 Positioning Controllers,</li> <li>• ESCON Servo Controllers and</li> <li>• other controllers.</li> </ul>
300586	Signal cable	To connect the adapter 488167 to an EPOS2 50/5 or EPOS3 EtherCAT controller
378173		To connect the adapter 488167 to an EPOS2 70/10 controller
451290		To connect the adapter 488167 to a MAXPOS controller
For further details → maxon catalog		

Table 18 Suitable Accessories

### ADAPTER EASY ABSOLUTE (488167)

The adapter converts the single-ended clock and data signals of an ENX 16 EASY Absolute into TIA/EIA RS-422-compliant differential clock and data lines.

Driver/receiver component used: SN75179BD or compatible.

Parameter	Conditions	Min	Typ	Max	Unit
Operating temperature ( $T_{amb}$ )		0		70	°C
Supply voltage ( $V_{CC}$ )		4.75	5	5.25	V
Supply current ( $I_{CC}$ )	Without encoder, no load		57	70	mA
Maximum Clock frequency ( $f_{clk}$ )				10	MHz

Table 19 Adapter EASY Absolute



#### Note

The operating voltage range of the adapter is narrower than that of the ENX 16 EASY Absolute. The controller's voltage supply at the absolute encoder interface must provide the current of both adapter and encoder (typically a total of 74 mA).

••page intentionally left blank••

